

**GIGABYTE™**



## **GSmart i300 Copyright**

---

All mobile products by GIGA-BYTE Communications mentioned in this document, including the device, accessories, software, text, music, and pictures, are owned by, or authorized by original manufacturers to GIGA-BYTE Communications. Reproduction, transfer, distribution, or storage of part or all of the contents in this document in any form without the prior written permission of GIGA-BYTE Communications Inc. is prohibited.

GIGA-BYTE Group, GIGA-BYTE Communications Inc.

2 0 0 6

## **Safety Information**

---

This chapter contains important information on safe and efficient operation. Please read this information before using the device.

### **Exposure to Radio Frequency (RF) Energy**

The device contains a transmitter and a receiver. When it is ON, it receives and transmits RF energy. Please use the device appropriately.

### **Specific Absorption Rate Data**

The highest SAR value for this device when tested for use at the ear is 0.314 W/kg.

### **Road Safety**

Check the laws and regulations on the use of phones in the area where you drive. Do NOT use this device unless you use hands-free operation while driving or riding.

### **Potentially Explosive Atmospheres**

Turn off your phone prior to entering any area with a potentially explosive atmosphere such as gas stations, explosive chemicals, or flammable objects.

### **Aircraft Safety**

While in flight, switch the device to flight mode (turn off phone or wireless functions). When instructed to do so, turn off your phone when on board an aircraft.

### **Facilities**

Turn off the device in any facility where posted notices instruct you to do so. These facilities may include hospitals or health care facilities that may be using equipment that is sensitive to external RF energy.

### **Approved Accessories and Batteries**

Use only original or manufacturer approved accessories, batteries and chargers.

## **General Information**

This chapter contains important information on safe and efficient operation. Please read this information before using the device. Ignorance of the following notices may lead to violations of the law.

- ➔ Before using the device, please make sure you have fully charged the battery.
- ➔ Do NOT remove the battery from the device during charging.
- ➔ Before inserting SIM card into the device, make sure that the device is switched off.
- ➔ Do NOT attempt to disassemble the device on your own. This should be done by an authorized person.
- ➔ Use the device in accordance to instructions when in public facilities.
- ➔ In some countries, it is a violation against the law to record phone conversations. Always ask permission of the other party when you are going to record a conversation.

## Table of Contents

<b>Chapter 1 Getting Started .....</b>	<b>8</b>
1.1 Getting to Know Your Device .....	08
1.2 Key Definition .....	11
1.3 Accessory .....	12
1.4 Install and Charge Battery .....	13
1.5 Using Stylus .....	13
1.6 Screen Alignment and Settings .....	13
1.7 Time and Date Settings .....	14
1.8 Power On/Off, Sleep Mode .....	14
1.9 My Information Setup .....	15
1.10 Password Setup .....	15
1.11 Device Lock .....	16
1.12 System Reboot and Reset .....	16
1.13 Protect Your Screen .....	17
1.14 Maintenance .....	17
1.15 Traveling Advice .....	17
<b>Chapter 2 Using the Mobile Device .....</b>	<b>19</b>
2.1 Today Screen .....	19
2.2 Start Menu List .....	20
2.3 Applications .....	21
2.4 Settings .....	22
2.5 Input Method .....	23
2.6 Multi-Language .....	24
<b>Chapter 3 Phone Functions .....</b>	<b>26</b>
3.1 Insert and Remove a SIM Card .....	26
3.2 Making a Call .....	26
3.3 How to Use Your Phone .....	27
3.4 Volume Adjustment .....	27
3.5 Contacts .....	28
3.6 Create a New Contact .....	28
3.7 Call History .....	29
3.8 Set Ringtone and Password .....	29
3.9 Sending Messages .....	30
3.10 Block List .....	30
<b>Chapter 4 Personal Settings .....</b>	<b>31</b>
4.1 Restore to Factory Settings .....	31
4.2 Easy-Touch Menu .....	31

## Table of Contents

4.3 Shutdown Animation .....	31
4.4 Wise Talk .....	31
4.5 Change Settings .....	34
4.6 Hints or Alert .....	35
4.7 Power Setup .....	35
4.8 Backlight .....	35
4.9 Search for a File or Information .....	36
4.10 Pop-Up Menu .....	36
4.11 Shortcut Key .....	36
4.12 Phone Settings .....	37
<b>Chapter 5 ActiveSync Synchronization Tool .....</b>	<b>39</b>
5.1 Install and Use ActiveSync .....	40
5.2 Synchronize via Bluetooth .....	40
<b>Chapter 6 Connections .....</b>	<b>41</b>
6.1 Internet Access .....	41
6.2 GPRS Connection Settings .....	41
6.3 Activating GPRS Connection .....	41
6.4 GPRS Wizard .....	42
6.5 Connecting with Your Personal Computer .....	42
6.6 Bluetooth Wireless Transmissions .....	42
6.7 Internet Sharing .....	42
6.8 Wi-Fi .....	43
6.9 USB .....	43
<b>Chapter 7 Receive And Send Message .....</b>	<b>44</b>
7.1 E-mail and Message .....	44
7.2 Synchronously Process Email .....	44
7.3 Directly Connect to Email Server .....	45
7.4 Establish Email Services .....	45
7.5 Use Email and Message .....	46
7.6 How to Use Push Email .....	47
7.7 How to Use MMS .....	48
<b>Chapter 8 Using Bluetooth .....</b>	<b>51</b>
8.1 Bluetooth Connection Settings .....	51
8.2 COM Ports .....	51
<b>Chapter 9 Multimedia .....</b>	<b>53</b>
9.1 Camera .....	53
9.2 Video Mode .....	53

## **Table of Contents**

---

9.3 Recorder .....	54
9.4 Photo Editor .....	55
9.5 Pictures & Videos .....	55
9.6 JAVA .....	55
9.7 Audio Mixer .....	56
<b>Chapter 10 Embedded Programs .....</b>	<b>57</b>
10.1 Calendar .....	57
10.2 Contacts .....	58
10.3 Tasks .....	59
10.4 Notes .....	60
10.5 Word Mobile .....	61
10.6 Excel Mobile .....	62
10.7 PowerPoint Mobile .....	63
10.8 Windows Media Player .....	63
10.9 Internet Explorer .....	64
10.10 Magnifier .....	65
10.11 Zip .....	65
10.12 Calculator .....	66
10.13 Game .....	66
10.14 STK (SIM Tool Kit) .....	67
10.15 SD Add-Ons .....	67
10.16 Sim Backup .....	67
10.17 GSMART Bluetooth Application .....	67
10.18 GPS Tracking .....	68
10.19 Location Message .....	68
10.20 Pocket Remote .....	69
10.21 SMS Scheduler .....	69
<b>Chapter 11 Device Maintenance .....</b>	<b>70</b>
11.1 Memory Management .....	70
11.2 Memory .....	70
11.3 Add or Remove Programs .....	71
<b>Chapter 12 Specifications .....</b>	<b>73</b>
<b>Chapter 13 FAQ .....</b>	<b>75</b>



# Chapter 1

## Getting Started



### CHAPTER 1

## 1.1 Getting to Know Your Device

This chapter introduces you to the hardware of the device and its function keys.

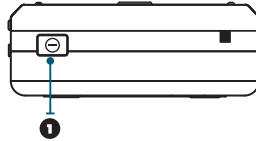

No.	Item	Function
1	<b>Power On / Off</b>	Press and hold the power button for a few seconds to turn on / off your device.
2	<b>LED Indicator</b>	The LED Indicator indicates the status of your device by showing different colors. Blue: Bluetooth is activated Orange: Wi-Fi is activated White: indication and GPS Green: mobile network detected
3	<b>Receiver</b>	You can hear caller's voice through receiver.
4	<b>Screen</b>	Display screen.
5	<b>Left Function Key</b>	Perform Menu or program command displayed on the down-left corner screen.
6	<b>Call Key:</b>	You can make or answer a call by pressing call key.
7	<b>Windows Flag Key(Flag Key):</b>	Press the flag key to open " Start " menu options.

2

3

4

5

6

7

8

9

10

11

12

13



## Getting Started

8	<b>Right Function Key:</b>	Perform the function of menu or program command displayed on the down-right corner screen.
9	<b>End Key</b>	Press this key to end a call.
10	<b>OK Key:</b>	Press: execute the function of the top-right screen (OK or X)
11	<b>Navigation Key</b>	Use up, down, left and right directions to navigate. Press the center key to execute the selected function or application.
12.	<b>Microphone:</b>	Receive your voice and conversation.
13	<b>Mini USB2.0/ Charging Slot</b>	Connect a charger adaptor to this slot to start charging. This slot is also a USB slot. You may connect the device to computers or other devices with USB cable and transfer files between the device and that device.

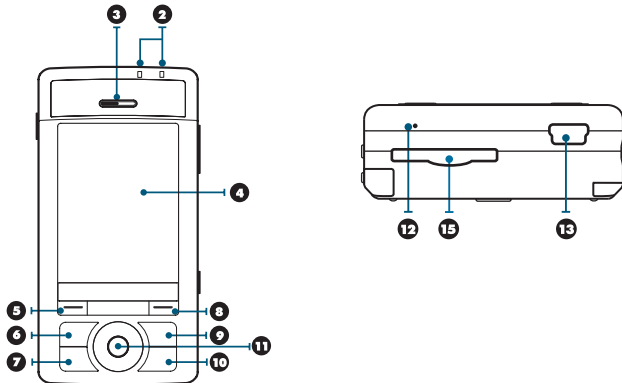

### CHAPTER 1

2

3

4

5

6

7

8

9

10

11

12

13

## Getting Started



### CHAPTER 1

2

3

4

5

6

7

8

9

10

11

12

13

14	<b>Headset plug</b>	You can listen to music via headset.
15	<b>Mini SD Card Slot</b>	You can insert your Mini SD card here to save data in your card.
16	<b>Reboot Button</b>	Press the reboot button to reboot your device.
17	<b>Camera Key</b>	Press and hold camera key to launch camera function.
18	<b>Volume Key</b>	Slide this key upwards or downwards to adjust volume.
19	<b>Loudspeaker</b>	You may play music / voice through speaker.
20	<b>Flash</b>	Support Auto Flash / Forced Flash On / Forced Flash Off mode.
21	<b>Stylus</b>	Use the stylus to touch the screen panel.

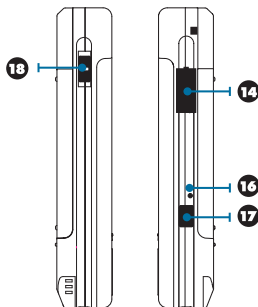

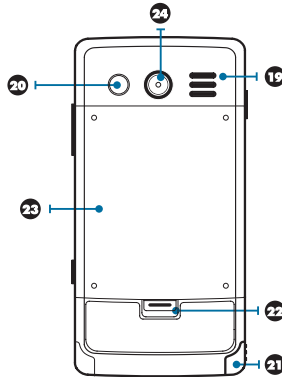

22	<b>Battery Lock</b>	Pull down the battery lock to remove a battery or to install a SIM card.
23	<b>Battery</b>	Provide power to your mobile device.
24	<b>Camera Lens</b>	Capture a photo or film a video through this lens.

- 2
- 3
- 4
- 5
- 6
- 7
- 8
- 9
- 10
- 11
- 12
- 13

## 1.2 Key Definition

Key	Function
5-Way Navigation Key - Up	Move cursor up
5-Way Navigation Key - Down	Move cursor down
5-Way Navigation Key - Left	Move cursor to the left
5-Way Navigation Key - Right	Move cursor to the right
5-Way Navigation Key - Center	Execution
Call key	Press: enter phone function. Press and hold: Enter Location Message

## Getting Started



### CHAPTER 1

2

3

4

5

6

7

8

9

10

11

12

13

End Key	Press: return to Today screen.
Power On / Off	Press: power saving mode Press and hold: power off
Flag Key	Press: Display/hide the "Start" menu. Press and hold: Display the Easy-Touch Menu.
OK Key	Press: execute the function of the top-right screen (OK or X)
Left Function Key	On Today screen, press to view Call history.
Right Function Key	On Today screen, press to view Contacts. Press and hold to enter GPS Tracking.
Camera Key	Press and hold : Camera mode Press in halfway and hold(In camera mode):execute auto focus Press deeply(In camera mode):take a picture
Volume Key	Slide up: increase volume. Slide down: decrease volume.
Reboot Button	Reboot your device.

## 1.3 Accessory

No.	Item	Function
1	Battery	Provide power to your device.
2	Charger	Charges the battery.
3.	Headset	Press the button on the headset to answer, pick up, or terminate a phone call.
4	USB Cable	Connects your device to your PC.
5	Getting Started CD	Contains ActiveSync .
6	User Manual and Quick Guide	Contain step by step guide on how to use your device.
7	Car Charger	Charge the battery in the car.
8	Stylus	Use the stylus to touch the screen panel.
9	Bluetooth Headset(Available in selected locations. Please ask your location distributors. )	Press the button on the headset to pick up, terminate a phone call, listen to music or execute Location Messages.

## 1.4 Install and Charge Battery

When using the device for the first time, please make sure the battery is installed and fully charged.

1. Insert a battery to the battery slot.
2. Plug your charger into an outlet and plug the other end to your device. The device will start charging automatically.
3. It takes 3 hours to fully charge your battery with a traveler charger for the first time. On a deskstand, it takes 6-8 hours to fully charge your battery for the first time. Unplug the device from the charger when charging is complete, and you may now use the device.
4. When the LED light is in red, it means the battery is charging.
5. When the LED light is in green, it means the charging is complete.
6. The battery icon on task bar on Today screen shows the battery status. You may also check the battery status in "Start" > [Settings] > System Tab > Battery Tab.

## 1.5 Using Stylus

Use the stylus to touch or write on your screen. Using stylus can avoid damaging your screen. There are 2 ways to use your stylus:

- 1. Tap:** softly tap on a desired item by your stylus, and lift the pen from the screen.
- 2. Press:** touch and hold your stylus on a desired item for a few seconds until a blue dotted circle appears. This indicates that a pop up Menu is going to be activated.

## 1.6 Screen Alignment and Settings

When using the device for the first time, screen alignment is required. If you find that the device does not accurately respond to your stylus taps, or you have performed a system reset, you need to align your screen.

1. Tap "Start" > [Settings] > System Tab > [Screen] > General Tab.
2. Tap { Align Screen } on your screen.
3. On the align screen, use your stylus to touch the crosses on the screen accurately.



## Getting Started



### CHAPTER 1

2

3

4

5

6

7

8

9

10

11

12

13

4. Tap " OK " to exit.

You can also choose your screen display in Portrait or Landscape.

1. Press and hold OK any time when the device is on to switch your screen display between Portrait and Landscape.

You can also change the default screen display by following the steps below:

1. Tap "Start"> 【Settings】 > System Tab > 【Screen】 > General Tab.

2. On General Tab screen, select your desired orientation. Portrait, Landscape Right-Handed, Landscape Left - Handed.

3. Tap " OK ", the screen will change accordingly.

## 1.7 Time and Date Settings

When using the device for the first time, you are required to set your time zone, time, and date. You can also tap on the clock icon on Today's screen to setup time and date.

1. Tap "Start"> 【Settings】 > System Tab > 【Clock & Alarms】 > Time Tab.

2. Select { Home } or { Visiting }.

3. Select your time zone.

4. Select AM / PM.

5. Use the up and down arrow aside hour, minute and second to adjust the highlighted time unit.

6. Tap the down arrow aside the date to open a calendar, and select a desired month, date, and year.

7. Tap " OK ", a pop - up window will appear on your screen to confirm to " Save Changes to the clock settings ".

8. Tap " Yes " to save the changes, and exit.

## 1.8 Power On / Off, Sleep Mode

Press Power On / Off key on the top of the device to turn on the device.

### Sleep Mode

1. Sleep Mode is a power saving mode designed to reserve battery power. After idling for a

period of time, the device automatically enters Sleep Mode. You may also manually enter Sleep mode by pressing power On / Off key shortly. The backlight of the screen will turn off and the device will go into Sleep mode. When in Sleep mode, your device will show no response to any operation or touches on the screen and keypad.

2. Press the power On / Off key again to exit Sleep mode.

3. You may set the time to activate Sleep mode. The device will automatically enter Sleep mode when no operation is done within that time.

- Tap "Start" > [Settings] > System Tab > [Power] > Advanced Tab.
- Check "Turn off device if not used for" Please select" On battery power" or "On external power".
- Select your desired time period.
- Tap "OK" to complete this setting.

### Power Off

To turn off the device, press and hold Power On / Off Key on the top of the device for about 5 seconds while the power is on.

## 1.9 My Information Setup

You can input your personal information to the device in Owner Information.

1. Tap "Start" > [Settings] > Personal Tab > [Owner Information] > Identification Tab.
2. Tap on "Name" field and input your name.
3. Tap on a desired input field and input your information.
4. Tap on the **Notes** tab to input other information you would like to display on your device.
5. If you want your information to be displayed on the starting screen, tap on the **Options** tab, and check both "Identification Information" and "Note".
6. Select "OK" to finish setup and save it.

## 1.10 Password Setup

You can set your own password to prevent unauthorized use of your device.

1. Tap "Start" > [Settings] > Personal Tab > [Lock] > Password Tab.



## Getting Started



### CHAPTER 1

2

3

4

5

6

7

8

9

10

11

12

13

2. On **Password** tab screen, check " Prompt if device unused for ".
3. Select an appropriate time.
4. Select a password type in " Password Type " field.
5. Input your password in the " Password " field and reconfirm the password in " Confirm".
6. Tap " OK ", a pop-up window will appear to confirm " Do you want to save password settings changes?".
7. Tap " Yes " to finish settings and save the changes; " No " to cancel.
8. You may also input password hint message under the Hint tab screen.
9. Tap " OK " to save your inputs.

**Note:** If you forget your password, you need to perform system default, which will lose all your data and settings.

## 1.11 Device Lock

On " Today " screen, tap { Device unlocked } to lock your device. When the device is locked, the device will not respond to touches on screen nor will it react to any input on the keypad. You can enable device lock after entering Sleep mode by pressing the power key. To enable this setting, please follow the steps below:

Tap " Start " > [Settings] > System Tab > Power > Extended Tab

Check "Lock device when device enter stand-by".

### Unlock device:

1. Tap { Unlock } on the bottom left of the screen, or press the left function key.
2. Tap the { Unlock } button on the newly appeared screen and the device is unlocked.

## 1.12 System Reboot and Reset

### Reboot System:

When you reboot the device, all running programs will stop and you will lose all unsaved information. Please make sure that all information has been saved before performing system reboot.



- 1.Reboot button is located on the bottom right side of your device.
- 2.Use the stylus to softly poke the reboot button on the lower right side of the device to reboot your system.

### System Reset:

When executing system reset, you are performing a clean boot on the device. It will remove the programs you have installed on this device, and reset all settings and information back to factory defaults.

- 1.Turn off the device.
- 2.Press the Flag key and OK key at the same time, and press Power key while still holding Flag key and OK key.
- 3.This device will restore to system defaults and reboot.

## 1.13 Protect Your Screen

To avoid damaging your device screen and camera lens, please do not drop, smash, or place pressure on the device.

## 1.14 Maintenance

To maintain the device in the best condition, please follow the suggestions below:

- 1.Please avoid exposing your device to extreme environment (too hot / too old / high humidity).
- 2.Please keep the device away from rain and water.
- 3.Please keep the device away from direct exposure to the sun and ultraviolet rays.
- 4.Place the device in the case when you are not using it.

## 1.15 Traveling Advice

Please follow the suggestions below when you are traveling with the device:

- 1.Back up your data.
- 2.Copy your data in a mini SD card.



## Getting Started



### CHAPTER 1

4. Remove all other connected device.
5. Bring your charger.
6. Place your the device in the case.
7. If you are in an air plane, please make sure that you have turned your device into the flight mode.
8. Make sure you have brought a specific adapter for the country you are traveling.

2

3

4

5

6

7

8

9

10

11

12

13



## Chapter 2

### USING THE MOBILE DEVICE

# 2.1 Today Screen

- 1.Start Menu :** Tap to open the start menu list.
- 2.Battery Status :** Shows the current battery status.
- 3.Connection Status :** Shows the connection status of the device.
- 4.SIM Card Status :** Shows SIM card status.
- 5.Volume :** Tap to adjust the speaker or phone volume.
- 6.Time :** Shows time and the latest appointment.
- 7.Today Screen :** Shows all important information of today.
- 8.Call History :** Tap to enter Call History.
- 9.Contacts :** Tap to view your Contacts.
- 10.Quick Launch :** Tap on an icon to launch that program.

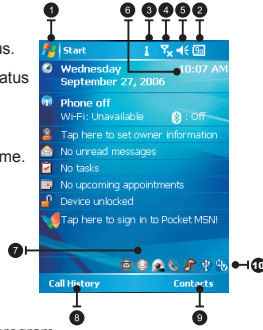

Icon	Description
	All sound alerts are on.
	Sound alerts off.
	No SIM card.
	Main battery power is full.
	Low Battery. Please recharge.
	Charging.
	You have one or more MSN messages.
	You have one or more email, messages, or voicemail messages.
	Magnifier is running in the background.
	Recorder is recording.
	You have new messages in answer machine.
	Headset is plugged in.

1



CHAPTER  
2

3

4

5

6

7

8

9

10

11

12

13

## USING THE MOBILE DEVICE

1



CHAPTER  
2

3

4

5

6

7

8

9

10

11

12

13

	You have missed calls.
	Tap this icon to reveal all status icons.
	Mobile phone is off (Flight mode).
	Mobile phone is on.
	GPRS is available.
	GPRS is disconnected.
	GPRS is connected.
	Bluetooth is activated.
	GPS Tracking is trying to connect.
	GPS tracking is connected.
	Location Message is trying to connect .
	Location Message is connected

Note: There are several shortcuts on the bottom right of Today screen. You can choose to show or hide these shortcuts. To show or hide the shortcuts, select " Start " > [Settings] > [Personal Tab] > [Today] > [Extended] .





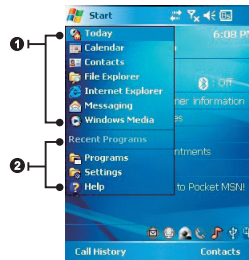









## 2.2 Start Menu List

- 1.The applications in this block are fixed for some Microsoft applications.
- 2.The applications in this block are the last 5 programs that you have used.
- 3.Tap on **Programs**, to enter the programs screen.
- 4.Tap on **Settings**, to enter the settings screen.
- 5.Tap on **Help**, to see detail information about your device.



## 2.3 Applications

You will see many application icons on your **Programs** screen. From the **Programs** screen, you may touch on the application icon that you desired to use to execute the application.

Icon	Program	Description
	【Multimedia】	【Camera】 , 【Photo Editor】 , 【Pictures & Videos】 , 【Recorder】 , 【JAVA】
	【Tools】	【Magnifier】 , 【Zip】 , 【Easy-Touch Menu】 , 【GSMART Bluetooth Application】 , 【GSMART for Sktpc】 , 【Restore to Factory Settings】 , 【Torch】
	【Phone Manager】	【Block List】 , 【Internet Sharing】 , 【Download Agent】 , 【Dial Kit】 , 【Sim Backup】 , 【SMS Scheduler】
	【Games】	【Bubble Breaker】 , 【Solitaire】 , 【Pocket Sudoku】
	【ActiveSync】	Transmit data between your computer and the device.
	【Pocket MSN】	Perform MSN functions.
	【Excel Mobile】	Execute Excel files.
	【PowerPoint Mobile】	Execute PowerPoint files.
	【Word Mobile】	Execute Word files.
	【Calculator】	Perform basic calculations.
	【Notes】	Write notes, memo, or drawings.
	【Search】	Search for all data, programs, and files.
	【Terminal Services Client】	Setup your server information.
	【GPS Applications】	【GPS Tracking】 , 【Location Message】



## USING THE MOBILE DEVICE

1



CHAPTER  
2

3

4

5

6

7

8

9

10

11

12

13

# 2.4 Settings

Learn about what you can do with Settings:  
Select " Start " > [Settings] > **Personal** Tab

Program	Description
Buttons	You may assign programs to hard keys.
Wise Talk	Activate/deactivate Answering Machine, Background Effects, and Phone Recorder, and related phone settings.
Input	You can set your preferred input method.
Lock	You may set a personal password for the device.
Menus	Select the programs to be displayed in Start menu.
MSN Options	You may set MSN password, account, and other details.
Owner Information	You may input your personal information.
Phone	Settings for phone functions.
Shutdown Animation	Settings for shutdown screen.
Sounds & Notifications	Settings for alarm sound and notification.
Today	Settings for screen appearance and display items.

Select " Start " > [Settings] > **System** Tab

Program	Description
About	Contains information of the device.
Backlight	Settings for backlight.
Certificates	Identifies the device to others to prevent unauthorized access.
Clock & Alarms	Settings for time and alarms.
GPS	Settings for using GPS function.
Memory	Memory status and running programs.
Power	Power status and wireless signals.
Regional Settings	Settings for region, number, currency, time, and date.
Remove Programs	Remove programs from your device.
Screen	Screen orientation, screen alignment, and text size.

Select " Start " > [Settings] > **Connections** Tab

Program	Description
Beam	You can choose to receive all incoming beams.

Bluetooth	Settings for Bluetooth function.
Connections	Settings and management for modem connections.
GPRS Wizard	Basic settings for GPRS connection.
Wi-Fi	Configurations for Wi-Fi.
USB	Use the device as a mini SD card reader.
Wireless Manager	Turn on/off Bluetooth, flight mode.

## 2.5 Input Method

### Screen Keyboard

You can input data by using screen keyboard. Tap on the keyboard icon  on your screen to open the screen keyboard. Follow the following steps below to input your data:

1. On your screen keyboard, tap **[Shift]** or **[CAP]** key to input a Capitalized letter or some common symbols. You can also double-tap on **[Shift]** to enter capital letters.
2. Tap the  key on your screen keyboard to delete.
3. To close the screen keyboard, tap the keyboard icon again on your screen to hide the screen keyboard.

### Letter Recognizer

1. On your screen keyboard, tap the arrow icon next to the keyboard icon for more input methods. On the pop-up list, tap **Letter Recognizer**.
2. Write letters and numbers in a corresponding field on your Letter Recognizer screen. The device will display the letters / numbers that you had just input in the Letter Recognizer fields.
3. Tap the  key to delete an input.

### Block Recognizer

1. On your screen keyboard, tap the arrow icon next to the keyboard icon for more input methods. On the pop-up list, tap **Block Recognizer**.
2. Write letters and numbers in a corresponding field, the system will display the letters/ numbers identified of your handwriting.
3. Do not write letters / numbers continually to prevent recognition error.
4. Do not write letters outside of the input fields.

1



CHAPTER

2

3

4

5

6

7

8

9

10

11

12

13

## USING THE MOBILE DEVICE

1



CHAPTER  
2

3

4

5

6

7

8

9

10

11

12

13



### Transcriber

1. On your screen keyboard, tap the arrow icon next to the keyboard icon for more input methods. On the pop-up list, tap **Transcriber**.
2. Position the cursor where you want text to appear.
3. Use the stylus to write anywhere on the screen. The handwriting will be converted to text after you lift the stylus from the screen.

Please Note: Due to different language versions of operating system, some (Russian for example) may not support Letter Recognizer, Block recognizer, and Transcriber.

### Smart Input

This input method allows you to edit text by pressing the screen keypad. Using this method, the number of key pressed required will be dramatically reduced.

1. On your screen keyboard, tap the arrow icon next to Keyboard icon for more input methods. On the pop-up list, tap Smart Input.
2. If you want to input "phone", for example, simply press the combination of the letters assigned to the following number string: "74663." Confirm the spelling you want by pressing .
3. Tap and hold  on the screen keypad. On the pop-up list, you can choose what types you need for input.

## 2.6 Multi-Language

The device supports multi-language automatically. If the documents don't show correctly, tap "Start" > Settings > System > Region and select the region and the language you want.

Supported languages in alphabetic order are:

Afrikaans, Albanian, Arabic (Saudi Arabia), Azeri (Cyrillic), Azeri (Latin), Basque, Belarusian, Bulgarian, Catalan, Chinese (Hong Kong S.A.R.), Chinese (Macau S.A.R.), Chinese (People's Republic Of China), Chinese (Singapore), Chinese (Taiwan), Croatian, Czech, Danish, Dutch (Belgium), Dutch (Netherlands), English (Australia), English (Belize), English (Canada), English (Caribbean), English (Ireland), English (Jamaica), English (New Zealand), English (Philippines), English (South Africa), English (Trinidad), English (United Kingdom), English (United States), English (Zimbabwe), Estonian, Faroese (Faroe Islands), Finnish, French (Belgium), French (Canada), French (France), French (Luxembourg), French (Monaco), French (Switzerland), FYRO Macedonian, German (Austria), German (Germany), German (Liechtenstein), German (Luxembourg), German (Switzerland),



## USING THE MOBILE DEVICE

Greek, Hebrew, Hungarian, Icelandic, Italian (Italy), Italian (Switzerland), Japanese (Japan), Korean (Korea), Latvian, Lithuanian, Norwegian (Bokmal), Norwegian (Nynorsk), Polish, Portuguese (Brazil), Portuguese (Portugal), Romanian, Russian, Serbian (Cyrillic), Serbian (Latin), Slovak, Slovenian, Spanish (Argentina), Spanish (Bolivia), Spanish (Chile), Spanish (Colombia), Spanish (Costa Rica), Spanish (Dominican Republic), Spanish (Ecuador), Spanish (El Salvador), Spanish (Guatemala), Spanish (Honduras), Spanish (International Sort), Spanish (Mexico), Spanish (Nicaragua), Spanish (Panama), Spanish (Paraguay), Spanish (Peru), Spanish (Puerto Rico), Spanish (Traditional Sort), Spanish (Uruguay), Spanish (Venezuela), Swahili, Swedish, Swedish (Finland), Tatar, Thai, Turkish, Ukrainian, Urdu (Islamic Republic of Pakistan), Uzbek (Cyrillic), Uzbek (Latin).

1



CHAPTER  
2

3

4

5

6

7

8

9

10

11

12

13



## Chapter 3

### PHONE FUNCTIONS

1

2



CHAPTER 3

4

5

6

7

8

9

10

11

12



13

Press  key, to enter phone function. Please insert a SIM card before using phone.

## 3.1 Insert and Remove a SIM Card

1. Before inserting / removing a SIM card, please make sure that the device is turned off and is not connected to any power supply by the USB cable or charger.
2. Remove the battery from the battery slot.
3. Insert / Remove the SIM card from the SIM card slot.
4. Replace the battery back to the battery slot.

## 3.2 Making a Call

1. After entering the phone function, you can dial a number using the dial keypad or the keypad on your screen.
2. To delete an error input, use  key on your screen.
3. Press  Key to make a call.
4. Press  Key to end the call.

### Speed Dial



You can set ten phone numbers in your speed dial list.

1. After entering phone function, press Menu > Speed Dial to enter your Speed Dial List.
2. On your Speed Dial List screen, you can select a contact on your list to see the contact's detailed information.
3. On Speed Dial List screen, tap {Menu} on the bottom right corner of the screen. You can perform {New}, {Edit}, or {Delete} contacts on your Speed Dial List.
4. To make a call, press the corresponding number on your keypad to call the contact on your speed dial list.
5. You can also use the navigation key to select a contact you want to call on the speed dial screen, and then press Call Key to call.
6. Press End Key to end the call.



### Smart Dial

Use this function to search a contact or a specific number quickly.



## PHONE FUNCTIONS

1. Press Call key to enter Phone, and then press the right navigation key on the 5 way navigation keys, or tap Menu > Smart Dial.
2. The smart dial screen will display all contacts in this device .
3. After inputting the first number/letter, the smart dial screen will display only the matching phone number and contacts on the screen. For example: after inputting 0, the smart dial screen will only display phone numbers which begins with 0.
4. When there is an input error, press the right navigation key to delete.
5. Select a number or contact you want to call, press  Key to call.
6. Press  Key to end the call.

### 3.3 How to Use Your Phone

Option	Operation	Answer Or Hang Up	Headset Volume Adjustment
Using Handheld Call	Place the handset close to your ear and the microphone close to your mouth.	Press  Key to answer, and press  Key to hang up.	You may adjust the volume using the volume key at the side of this device during a call.
Using Headset	Place the headset into your ears and aim the microphone at your mouth.	Press the key on headset to answer or hang up.	You may adjust the volume using the volume key at the side of this device during a call.

### 3.4 Volume Adjustment

Tap the  icon on screen and the volume adjustment window will appear. Adjust the volume of alert tone for all programs tapping on , and adjust the ring volume by tapping on .

1. Press the volume adjustment key on the side manually or tap  to adjust incoming call volume.

1

2



CHAPTER 3

4

5

6

7

8

9

10



11

12

13

## PHONE FUNCTIONS

1

2.If you press the volume adjustment key on the side of this device or tap  >  icons during a call, you may adjust the in - call volume of the phone. You can only adjust it when during a call.

2

3.When you select **Vibrate**, the  icon will change to  icon.

4.When you select **Off**, the  icon on screen will change to  icon.



### CHAPTER 3

4

## 3.5 Contacts

Under phone function screen,tap { Contacts } on the bottom left of the screen to enter Contacts.

1.Enter the contact or phone number you intend to search into the search field, the device will search for the contacts that match this condition.

2.Push and hold the 5 way navigation key upwards or downwards to browse contacts by initial letters in Contacts. (This function is available for contacts synchronized from Outlook only.)

3.Tap on any contact to view that contact's information.

4.Under contacts list screen, tap { Call } on the bottom left of screen or press the left function key to make a call to that person.

5.Under contacts list screen, tap { Menu } on the bottom right of screen for more options.

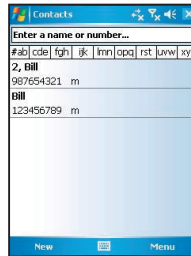

If you would like to make a call using telephone, go to **Contacts** and highlight the person you would like to make a call to. Tap Menu > Sounds DTMF; then aim the device to the telephone receiver. Your telephone will dial out to the desired contact upon reception of the DTMF sounds from the device.

5

6

7

8

9

10

11

12

13

**Note:** You may choose to display contacts in your SIM card by tapping { Menu } > " Show SIM Data ". The SIM contacts are indicated by a SIM card icon on the right side of the contacts.

## 3.6 Create a New Contact

In Contacts, Tap { **New** } on the bottom left of screen. A blank record will appear.

- 1.You may set photos in photo field for this contact, by which the contact's photo will display as an incoming call photo ID.
- 2.You may also tap ringtone field to set different incoming call ringtones for your contacts.
- 3.Tap "OK" on the upper right screen to save the new contact and exit.

## 3.7 Call History

Call History contains all outbound calls, incoming calls and missed calls. You may choose to display all or only display highlighted items.

- 1.Under Today screen, tap {Call History} on bottom left of screen.
- 2.Tap {Menu} on the bottom right of screen.
- 3.Select a desired function to perform. You may change call history display method by selecting {Filter}; or select {Call Timers} to check incoming call numbers, call time and manage incoming call history.
- 4.Under {Call History} screen, select the icon on the upper left side of main screen to redial this number at once.
- 5.Under {Call History} screen, tap and hold on a phone number to open drop down menu for more options.

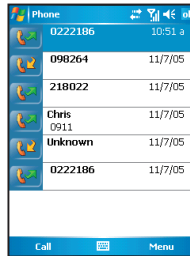

## 3.8 Set Ringtone and Password

After entering phone function, select { Menu } on the bottom right of the screen. Select { Options } > Phone tab from unfolded options.

- 1.You may select preferred ringer method.
- 2.If you want to download ringtones, please use ActiveSync program in computer and copy the ringtone file to **Application Data / Sounds** folder in this device. The ringtone files will be added as the options.
- 3.You can set keypad tone for dialing.
- 4.You can set personal password to prevent unauthorized use from others.

1

2



CHAPTER 3

4

5

6

7

8

9

10

11

12

13

## PHONE FUNCTIONS

1

2



### CHAPTER 3

4

5

6

7

8

9

10

11

12

13

## 3.9 Sending Message

To send a text message, select " Messaging " on Today screen to enter message function screen; or tap " Start " > Messaging.

1. Select " Inbox " on upper left screen, and then select files from message categories.
2. Select " Text Message " folder.
3. Select { New } on the bottom left of screen to create a new text message.
4. Input the phone number of recipient into recipient field, or select a recipient from { Menu } > { Add Recipient } on the bottom right corner of screen.
5. Input your message into content field.
6. Tap " OK " on the top right of screen. You may select whether to save this message in draft and send it out later, or directly tap { Send } on the bottom left of screen to send message.

## 3.10 Block List

You can choose to block specific numbers or block all unknown calls. When a blocked number calls, the screen will display incoming call alert and ring but will automatically hang up within 5 seconds.

Select " Start " > [Programs] > [Phone Manager] > [Block List]

1. Check " Block all unknown calls " or tap { Menu } and select { Add Block List } to add a number you would like to block.
2. Select " OK " to save the settings.

Alternatively, tap { Contacts } on Today screen, highlight the contact you would like to block and tap { Menu }. Select " Set to Block List ". You may also block numbers in Call History, or create new blocked numbers in Block List.



## Chapter 4

### PERSONAL SETTINGS

#### 4.1 Restore to Factory Settings

You can restore the system to factory settings by tapping this program. When you format the system, all user-created data and programs will be deleted. Please ensure that you have backed up important data before formatting. To start formatting, select "START" > Programs > Tools > Restore to Factory Settings.

#### 4.2 Easy-Touch Menu

Press and hold Flag key for about 3 seconds, and then release, to open Easy-Touch Menu. You can easily close programs, adjust backlight brightness, apply profiles, or setup bluetooth headset.

#### 4.3 Shutdown Animation

1. Select " Start " > [Settings] > Personal Tab > [Shutdown Animation]
2. Select your preferred Animation File, Sound File, Show Time. Tap User Define in " Animation File " to set your own file as shutdown animation.
3. Select " Preview " to view your settings.
4. Tap " OK " to save and exit.

#### 4.4 Wise Talk

Wise Talk contains additional handset related settings.

1. Tap " Start " > [Settings] > Personal Tab > [Wise Talk]
2. Answer Machine Tab: You may enable / disable Answer Machine, choose file location, set recording time, set hold on time before activating answer machine, or set your own greeting.
3. Background Effects Tab: You may enable / disable Background Effect, choose preferred background effect sound, or adjust volume.
4. Phone Record Tab: You may turn on / off phone recording, or choose a file location.

1

2

3



### CHAPTER 4

5

6

7

8

9

10

11

12

13

## PERSONAL SETTINGS

1

5. Phone Settings Tab: You may change phone related settings.

2

**Note:** When Answer Machine is activated, Background effects and Phone Recorder will not operate.

3

### **Answer Machine**

This function is different from voicemail, you may use answer machine in this device to directly save caller's message to this device, which allows you to listen to message more easily and also save call expenses. You can even choose to apply a specific greeting to an incoming call by tapping the icon appeared when an incoming call is ringing.

Select " Start " > [Settings] > Personal Tab > [Wise Talk] > Answer Machine tab.

1. Check "Enable Answer Machine" to activate answer machine function.
2. Select "Save In" to select a storage location for messages.
3. Select "Recording Time" to set the time length for a caller message.
4. Select "Activate Time" to set how many seconds that your answer machine will wait before answering an incoming call.
5. Select a greeting from {Greeting setup} to apply on incoming calls. To apply your own recordings as the greeting, select "User Define" from the pull down menu.

5

6. Tap " OK " to save setup and return to System tab screen.

6

You will find callers' messages in " My Answer Machine " folder.

7

### **Greeting Setup:**

Tap { Greeting Setup } to set default answer machine greeting or record your own greeting. Press the play button to listen to the current greeting.

8

1. Select a style to be your greeting message.
2. Tap the record button to record your own greeting.
3. Tap the play button to listen to greeting recorded.
4. Tap " OK " to validate the settings and exit.

9

10

11

12

13



## PERSONAL SETTINGS

### Note:

1. Your answer machine will stop recording as caller ends the call. After activating answer machine, you may press { Stop } to stop recording without interrupting the conversation. After activating answer machine, it will interrupt conversation and end recording by pressing Key.

2. When Caller 1 is leaving a message, the incoming call from Caller 2 will become call waiting and will be recorded in the message of Caller 1. You may select to answer or reject call waiting. If you select to answer call waiting, the message of Caller 1 will stop; if you select to reject call waiting, the call waiting from Caller 2 will continue to ring until Caller 2 enters voice mail.

3. If you have checked " Auto Answer " in Phone, Answer Machine will automatically be deactivated. See Settings in this Chapter. .

### Background Effects

You may use background effects to create the call environment you desire.

1. Select " Start " > [Settings] > Personal tab > [Wise Talk] > Background Effects tab.
2. Check " Enable Overdub " to activate background mixed sound function.
3. Tap { Background sound } to unfold special sound effect and select a special effect.
4. You may use { Background sound volume } bar on screen to adjust the volume of special effect.
5. Press " OK " to validate the settings and exit.

You may also use the files you have recorded as background effects. To do so, save the files under My Background Sounds in My Documents, then repeat step 1 to 5.

After activating background effects, when an incoming call rings, tap { Answer } to answer with the background sound you have selected, or tap on the 🎧 icon and choose " Off " from the drop down menu to answer without the background sound. You can also tap the 🎧 icon and choose a different background sound from the drop down menu to be applied to this particular call. Once you select the sound to be applied, it will automatically answer the phone and apply the newly selected special effect to that call.

### Phone Recording

You may use phone recording function to record your call contents.

1. Select " Start " > [Settings] > Personal tab > [Wise Talk] > Phone Record tab.
2. Check " Activate Phone Recording " to activate phone recording function.

1

2

3



## CHAPTER 4

5

6

7

8

9

10

11

12

13

## PERSONAL SETTINGS

1

3. Select " Save In " to select the storage location for your phone recording.

2

4. Press " OK " to validate the settings and exit.

3

You may find the recorded files in " My Phone Recording " folder.

When phone recording is activated, press Camera key to start in - call recording. Pressing Camera key again will cancel the recording. By the end of a call or by pressing stop recording key, the recording function will stop. During recording, the device will vibrate to indicate that the recording has started/stopped.



### CHAPTER 4

**Note:** If Background Effects is activated, the background special effect will be recorded during phone recording.

#### **Phone Setting:**

Select " Start " > [Settings] > Personal tab > [Wise Talk] > Phone Setting tab

- Auto Answer: The phone will automatically pick up incoming calls by the time period you defined.

- Play individual ringtone on Call-waiting: Play caller's ring tone during call-waiting to help you recognize the incoming caller.

- Turn off touch screen during call to save power : Temporarily turn off touch screen when you are in a call.

5

6

7

Note: Answer Machine, Background Effects, and Phone Recording can be enabled at the same time. However, while Answer Machine and Background Effects are active during phone calls, Phone Recording won't work.

8

9

10

11

12

13

## **4.5 Change Settings**

Select " Start " > [Settings] > and select Personal or System tab on the bottom of screen. You may change the following settings:

- " Clock & Alarms " : change time or set alarm.
- " Menus " : personalize your Start menu by selecting the items to be shown in the menu..
- " My Information " : input your contact information.
- " Password " : restrict access to your data.

## PERSONAL SETTINGS

- " Power " : extend battery lifetime.
- Lock device when device enter stand-by : When the device enters Sleep mode, it will automatically enable device lock.
- " Today " : personalize "T oday Screen " appearance and information. When you change your Today theme in Today > Theme tab, your Today background, phone skin, and theme color, will all change accordingly.

### 4.6 Hints or Alert

If you have already scheduled appointments in Calendar, job deadlines in Task bar, or alarm setup in Clock & Alarms, then this device will alert you according to your settings. You may select the following alert methods:

- Display message dialog on screen
- Play specified sound
- Flashing
- Vibration

If you want to select alert types and sounds, select " Start " > [Settings] > Personal tab > [Sounds & Notifications] > Notifications tab.

### 4.7 Power Setup

Select " Start" > [Settings] > System tab > [Power]

**Battery tab:** displays the power status.

**Advanced tab:** enable auto power off of the device.

**Extended tab:** enable / disable short press power key to lock device and enable/disable USB fast charging.

### 4.8 Backlight

1. Select " Start " > [Settings] > System tab > [Backlight] to set backlight functions.
2. Battery Power tab: set the turn on method and turn off time for backlight when using battery power.

1

2

3



CHAPTER  
4

5

6

7

8

9

10

11

12

13

## PERSONAL SETTINGS

1

2

3



### CHAPTER 4

5

6

7

8

9

10

11

12

13

3. External Power tab: set the turn on method and turn off time for backlight when using external power.

4. Extended tab: adjust the brightness of backlight.

## 4.9 Search for a File or Information

" Search " function may help you to rapidly find the information you desire.

1. Select " Start " > [Programs] > [Search]
2. Input the text you want to search in search field.
3. You may also select proper file type in type field to search the file you want.
4. Tap { Search } on the bottom left of screen to start searching the file.

You may also use [File Explorer] to search for files.

1. Select " Start " > [File Explorer]
2. Select the arrow on the top left corner of the screen to change a folder.
3. Select "Date" to change the order of file display.
4. Select a folder to view the files in that folder.
5. Tap and hold a file or on any blank space of the screen to open pop - up Menu.

To move files using [File Explorer] , select and hold the items you want to move, then select { Cut } or { Copy } from Menu and then select { Paste } after switching to proper directory.

## 4.10 Pop-Up Menu

Through pop - up Menu, you may easily select a desired item for execution. The pop-up Menu provided in each program is different. Tap and hold and then lift the stylus to open a pop - up Menu. Select an item from the Menu to execute. If you do not want to execute any item, tap anywhere outside the Menu to cancel.

## 4.11 Shortcut Key

You may set certain keys as the activation keys for your most common used programs.

## PERSONAL SETTINGS

1. Select " Start " > [Settings] > Personal tab > [Buttons] > Program Buttons tab.
2. Under **Program Buttons** tab screen, select desired function key.
3. In specified program field, select the program you want to set.
4. Tap " OK " to save and return to **Personal** tab screen.

Default assignments are:

Call Key(Press & hold): Location Message.

Right Function Key (Press & hold): GPS Tracking.

Flag Key (Press & hold): Easy-Touch Menu.

## 4.12 Phone Settings

You may make settings for Phone, Services, Network and other phone related settings.

Select " Start " > [Settings] > Personal tab > [Phone]

**Phone** tab: Settings include ring type, ring tone, keypad tone and security PIN.

**Services** tab: Settings include Call Barring, Caller ID, Call Forwarding, Call waiting, Voice Mail and Text Messages, and Fixed Dialing.

**Network** tab: Settings include current network, preferred networks, and network selection.

**Information** tab: This tab provides device related phone information.

### Services:

- 1.Select " Start " > [Settings] > Personal tab > [Phone] > Services tab.
- 2.Check the items you want to select.
- 3.Tap " OK " to save settings and return to **Personal** tab screen.

**Note:** All services in **Services** are provided by operators. Please contact your operator for enquiries regarding these services.

1

2

3



CHAPTER  
4

5

6

7

8

9

10

11

12

13

## PERSONAL SETTINGS

1

2

3

### **Network:**

Select " Start " > [Settings] > Personal tab > [Phone] > Network tab

- Under **Current network**, tap " Find Network " to automatically search for the network in use.
- Under **Network Selection**, select " Automatic " or " Manual " to select network automatically or manually.
- Under **Preferred networks**, tap " Set Networks " to set your preferred order of network.



CHAPTER  
4

5

6

7

8

9

10

11

12

13



## Chapter 5

### ACTIVESYNC SYNCHRONIZATION TOOL

You may use Microsoft ActiveSync to synchronize data in this device with personal computer.

- You can synchronously update Outlook data in this device and in your personal computer.
- You can synchronize Microsoft Word and Microsoft Excel files in this device and in your personal computer. The files will automatically convert to the compatible version.

The default of ActiveSync is not to automatically synchronize all data. If you would like to change the default, you may activate or disable the synchronization function for specific data in **ActiveSync Option**.

ActiveSync may also be used for the following purposes:

- Backup or restore saved data in this device.
- Copy files between this device and personal computer.
- Synchronize while connecting to your personal computer or selecting synchronization command.
- Synchronize specific types and range of files. For example, you may choose to synchronize appointments of the past few weeks.

## 5.1 Install and Use ActiveSync

**Note:** Before installing ActiveSync, do not connect your device to the computer. You may only connect the device to the computer by using the USB cable AFTER ActiveSync is installed.

### 1.ActiveSync Installation:

use the enclosed CD to install Microsoft ActiveSync in your personal computer. This device already has built-in ActiveSync.

### 2.Hardware Installation:

connect this device with your personal computer by using the USB cable.

### 3.Use ActiveSync Program:

After completing installation, setup wizard will lead you step by step. Please follow the instructions to make setup basing on your demand.

After connecting this device with your personal computer by using the USB cable,the computer screen will display " Connected " upon successful connection.A green icon

1

2

3

4



CHAPTER 5

6

7

8

9

10

11

12

13

## ACTIVESYNC SYNCHRONIZATION TOOL

1

representing " connected " will appear on the task bar of your computer screen. Select the Browse button of ActiveSync program of your personal computer, to view the files in this device. You may manage several files in the device simultaneously.

2

3

4

## **5.2 Synchronize via Bluetooth**

Instead of using a USB cable, you may also synchronize data via Bluetooth. Select " Start "> [Programs] > [ActiveSync] > {Menu}, then select { Connect via Bluetooth } and tap " Synchronize " in this device to process synchronization. For descriptions regarding synchronization through Bluetooth device, please refer to Synchronizing Your Information > Connect to a PC via Bluetooth in device Help.

When using GPRS and Internet connection, you will not be able to answer a call. If you want to make a call, your device will automatically disconnect to the Internet and reconnect



### CHAPTER 5

6

7

8

9

10

11

12

13





## Chapter 6

### CONNECTIONS

to the Internet at the end of conversation.

## 6.1 Internet Access

Before using GPRS to connect to the Internet, please confirm with your system provider whether this service is enabled and supported on your SIM card. If you already have a SIM card, then you only need to apply to your system provider for GPRS function. It is convenient for you to work at home or travel by using GPRS. You can use this device to browse web pages, read or send Email, text or MMS messages, and MSN messages through wireless network.

## 6.2 GPRS Connection Settings

1. Select " Start " > [Settings] > Connections tab > [Connections] > Advanced tab.
2. Select {Select Networks} to open Network Management screen.
3. Select a desired network name from the list; press { New } to add available network to list; press { Edit } to modify original network setup content.
4. Tap " OK " to save and exit.

## 6.3 Activating GPRS Connection

If this device is under flight mode, please turn off flight mode beforehand.

Tap  icon on Today screen, then tap " Wireless Manager " on the pop - up window. Tap on " Phone " to turn the phone function on. The  icon will appear on Today screen when GPRS is activated.

1. Tap " Start " > [Internet Explorer] .
2. Input an URL address you desire to browse in address field and tap the arrow icon to go to the URL.
3. After completing connection, icon will become icon.
4. Or you may select " Start " > [Settings] > Connections tab > [Connections] > Tasks tab > Manage Existing Connection > tap and hold on a connection to open pop-up Menu > Connections.

1

2

3

4

5



CHAPTER 6

7

8

9

10

11

12

13

## CONNECTIONS

1

After completing connection, you may go Internet surfing or send and receive email.

2

### **6.4 GPRS Wizard**

3

GPRS Wizard helps you to manually select your GPRS network with more ease.

4

1. Tap " Start " > [Settings] > Connections tab > [GPRS Wizard]
2. Choose the regional name of your location.
3. Choose the desirable network, or tap " Add " to add new networks.
4. Tap " OK " to save the changes and exit.

5



## CHAPTER 6

7

### **6.5 Connecting with Your Personal Computer**

If you want to connect this device with your personal computer, please see "Chapter 5 ActiveSync Synchronization Tool".

8

### **6.6 Bluetooth Wireless Transmissions**

If you want to use Bluetooth function connection in this device, please see Chapter "Using Bluetooth".

9

### **6.7 Internet Sharing**

10

You can set the device as a wireless modem. Internet Sharing allows your PC/Notebook be connected to a wireless network. Before creating a new modem via the selected connection type, you still need to install the drivers on your PC/Notebook. Please find the drivers in the ActiveSync and Application Software CD.

11

1. Tap Start > Programs > Internet Sharing.
2. Select a USB or Bluetooth PAN as PC Connection type.
3. Connect your phone via USB cable or Bluetooth to a PC/Notebook, and then tap Connect.

12

13

**Note:**

Before you tap Connect, please make sure that you have installed a GPRS SIM card, and that you have connected this phone to your PC/Notebook by USB cable or Bluetooth and disabled ActiveSync.

### 6.8 Wi-Fi

Wi-Fi allows this device to connect with detected network through Wi-Fi.

1. Select "Start" > [Settings] > Connections tab > Wireless Manager.
2. Tap {Wi-Fi}.
3. Tap "OK" to activate wireless network and exit.

After activating Wi-Fi, a new window, "New Network Detected", will appear. Select Connect and enter your password to the local network. Press Connect to connect this device with local network.

**Note:**

Reboot is required when you change the IP address in "Start" > Settings > Connections Tab > Network Cards > Network Adaptors Tab > IP Address.

### 6.9 USB

You may use the device as a mass storage device or a Mini SD card reader.

1. On the device, select "Start" > [Settings] > Connections tab > [USB]
2. Tap "SD Card Reader", and then press "Change".
3. Connect the device to the computer with USB cable.
4. Your PC will automatically detect the new hardware. Now you can view or transfer files to and from your mini SD card.

1

2

3

4

5



7

8

9

10

11

12

13



## Chapter 7

### RECEIVE AND SEND MESSAGE

1

2

3

4

5

6



CHAPTER  
7

8

9

10

11

12

13

## 7.1 E-mail and Message

Before receiving and sending your email or message, please make sure that this device has connected to a network.

When you are connected to a network, you may go to [Messaging] to receive and send your email or message.

#### **You may:**

1. Use this device to directly connect with email server and receive or send letter.
2. Synchronously update the Microsoft Outlook or Microsoft Exchange Server email in this device and personal computer.

The synchronization function of inbox does not support Microsoft Outlook Express.

#### **For more information on Email:**

1. See " Establish Email Service ".
2. See " Use Email and Message ".

#### **For more information on Short Message Service (SMS):**

1. Set your mobile phone message center number: select " Start " > [Messaging] > { Menu } > Tools > Options > Accounts tab.
2. See " Use Email and Message " unit.

For receiving and sending text messages (SMS), you only need to ensure that the phone function is activated the satellite icon on the top of outline bar shows . It is not necessary to activate GPRS connection nor establish new email account and connection in Messaging.

For MMS (Multimedia Message Service), please read "7.7 How to use MMS".

## 7.2 Synchronously Process Email

If you want to synchronously process email, you must activate the " Inbox " synchronization function in ActiveSync beforehand. For more information on " Inbox " synchronization, please see the online Help of ActiveSync in your computer.

#### **Inbox synchronization process rules:**

1. See " 6.1 Internet Access ". Please select a desired cooperation relationship on " New Cooperation Relationship " screen in computer to synchronously transmit information.

## RECEIVE AND SEND MESSAGE

If you select not to perform synchronization, you may manually copy or move email messages between this device and the computer.

2.Only the mail in " Inbox " of your computer will be synchronized.

3.Only the mail in Exchange or Outlook can be synchronized.

4.The mail from " Outbox " folder in this device will be sent to your computer first, and then it will be delivered through Microsoft Exchange Server or Microsoft Outlook.

5.If a specific letter is deleted in this device, then it will also be deleted in your computer when you reconnect this device with computer.

6.SMS in this device will not be synchronized.

### 7.3 Directly Connect to Email Server

You may directly receive new email from email server without connecting to a computer. You may select to use it online or offline; if it is online,you may directly read and reply mail when this device is connected to email server. You can reply a mail directly by simply tapping " Send ".

You may select to disconnect to the internet after downloading only the subjects of new messages or partial messages and decide whether to download the full message later. When you reconnect next time, the " Inbox " will download in accordance to appointed methods, and send out unsent email in Outbox.

You may choose to read just the mail within the last few days, mail subjects only, or complete mail. You can also choose to receive only the attachments less than specific file size. To make these settings, select Messaging > { Menu } > Tools > Options, and change email account setup by requirement.

### 7.4 Establish Email Services

If you have email accounts from ISP or company network, you may use [Messaging] to receive or send email. Please refer to the following instructions to set up a new email account in [Messaging] of this device.

1.Please acquire the following information from ISP or company network administrator:

- Email address, user name and password.
- POP3 or IMAP4 server name of Intranet mail

1

2

3

4

5

6



CHAPTER

7

8

9

10

11

12

13

## RECEIVE AND SEND MESSAGE

1

- SMTP server name for outgoing mail

2

2.Establish Email Services:

Select Messaging > { Menu } > Tool > New Account, and then follow the instructions on the screen to set up a new email account.

3

3.See " 6.1 Internet Access " to connect this device to a network and start receiving and sending email and messages.

4

4.Connect with Email Server:

Select [Messaging] > { Menu } > Send and Receive.

5

Select [Messaging] > { Menu } > Tool > Options > Account tab to change email account settings.

6



### CHAPTER 7

8

9

10

11

12

13

## 7.5 Use Email and Message

**The main functions of [Messaging] are stated as follows:**

- 1.Tap " Inbox ▼ " on the top left corner of the screen for a folder name.
- 2.Tap " Date ▼ " on the top right corner of the screen for mail arrangement.
- 3.Tap and hold on a mail to open mail content.
- 4.Tap and hold on the mail to open pop-up menu.
- 5.Select { New } to create new a email or message.
- 6.Select the keypad icon  on the bottom center of the screen to activate or disable screen keypad.
- 7.Select { Menu } to view menu.

**Compose and send mail:**

Select [Messaging] > " New "to write a new mail. After writing a new mail, select " Send " on the bottom left of screen and send this new mail.

**When composing a new mail,you can:**

- 1.Tap " To, CC, BCC " fields to input receivers' email addresses.
- 2.Tap " Subject " field to input a subject for your new mail
- 3.You may enter mail content in the empty area on the bottom half of the screen.
- 4.Select { Send } to start sending your mail.
- 5.Select the icon on the bottom center of the screen to activate or disable screen keypad.

## RECEIVE AND SEND MESSAGE

6. Select { Menu } to open menu.

Under new mail screen, select and hold to activate related Menu.

### Read and reply mail:

Select [Messaging] > { Menu }, and then select Send and Receive from { Menu } to start sending and receiving new mail. Select "Inbox" on the bottom left of screen to view Inbox. Tap on any unread mail to view its content.

### When reading mail, you can:

1. Tap on a contact in "To, CC, BCC" fields to save this contact as a new contact.
2. Tap { Reply } to compose a reply email.
3. Select the  icon on the bottom center of the screen to activate or disable screen keypad.
4. Select { Menu } to open menu.

On the mail content screen, select and hold to activate pop-up Menu.

## 7.6 How to Use Push Email

With push e-mail, you can have access to new incoming e-mail in real time. This Direct Push Technology can be enabled by the Exchange Server 2003 administrator, bringing the latest information to you. To use push email, please turn on Wi-Fi or GPRS to connect to the Exchange Server.

### Enabling Direct Push on your PC:

1. Connect your device to the PC using USB cable.
2. On the ActiveSync pop-up window, check "Synchronize with Microsoft Exchange Server or Personal Computer" and click on "NEXT".
3. Enter your network login name, password, and domain name. If your server requires a SSL encryption, please check "This server requires an encrypted (SSL) connection." Click on "NEXT".
4. Check the items you would like to synchronize, for example, you may check Inbox, Calendar, Contacts, or Tasks.

### Enabling Direct Push on your device:

1. On your device, select "Start" > Programs > ActiveSync > Menu > Add server source.
2. Input the IP address of your server in "Server Address".
3. Input your network login name, password, and domain name, and then tap "NEXT".
4. In ActiveSync on your device, select Menu > Schedule

1

2

3

4

5

6



## CHAPTER 7

8

9

10

11

12

13

## RECEIVE AND SEND MESSAGE

1

5. Set the Peak times to “As items arrive” and the Off-peak times sync time to “As items arrive”. Tap “OK”.

2

Now you have established a cooperative relationship for the device and the Exchange Server. The next time when you select “Start” > ActiveSync > Sync, you may synchronize with Exchange Server using Wi-Fi or GPRS.

3

4

Once you are connected to the network, you may look up your Global Address List over the air from your device by tapping “Contacts”. You may send an email to a contact on your Global Address List following the same steps as sending email to a contact saved on your device.

5

6

### Note:

To be able to use direct push, you need to have an exchange server. Microsoft Exchange Server 2003 also supports useful functions such as remote device wipe. To find out more on the benefit and usage of Microsoft Exchange server, please visit Microsoft's website, <http://www.microsoft.com>.



## CHAPTER 7

# 7.7 How to Use MMS

Before using MMS, please go to [Messaging] > { Menu } > [MMS Settings] to setup MMS. Please refer to “MMS Settings” for details.

### Compose and Send MMS:

Select [MMS] in [Messaging], then select { New } to write a new MMS. Tap { Send } on the bottom left of the screen to send the message.

### When composing a new message, you can:

1. Tap “ To, CC, BCC” fields to input receivers' phone number.
2. Tap “ Subject” field to input a subject for your new message.
3. Tap “ Insert Picture / Video...” or “Insert Audio...” to insert media attachments.
4. If the message contains more than 1 page, you may switch between pages via { Menu } > { Slides } > { Next } or { Previous }
5. You may input text content in the empty area on the bottom half of the screen.
6. Select { Preview } in { Menu } to preview the edited message
7. Select { Send } to start sending your message.

8

9

10

11

12

13



## RECEIVE AND SEND MESSAGE

8. Select { Menu } to open menu.

In { Menu }, you may insert voice and video clip, add page, and change background color of MMS.

### Read and Reply Messages:

Select Messaging > { Menu } > Inbox to view all received MMS messages. Select { Menu } > { Send / Receive } to receive new MMS. Select any unread mail in Inbox to view content.

### When reading MMS, you can:

1. Select {Reply} to reply to this MMS.
2. Select {Menu} to open menu.
3. If you would like to save the attached multimedia files in MMS, select { Menu } > { Save Media}

Tap and hold on a message in Inbox to open pop-up menu.

### Switch Accounts:

You may switch MMS to SMS or Outlook mailbox by selecting " Start " > Messaging > MMS > { Menu } > { Switch Accounts }.

### MMS Settings:

Select " Start " > [Messaging] > MMS > { Menu } > " MMS Settings ".

#### You can:

1. Select your system provider.
2. If you want to change your system provider, tap { Change }.
3. Select your preferred sending and receiving method.
4. Set MMS message file size.
5. Set MMS message categories in **Advanced** tab.
6. Press " OK " to save Settings and exit.

### Other settings:

You may manage folders and add new accounts in " Start " [Messaging] > MMS > { Menu } > { Tools }

### Pocket MSN:

Pocket MSN provides you MSN function in this device, including MSN Messenger, MSN Hotmail, Compose Hotmail, MSN Mobile Home, and Pocket MSN Help. To use these functions, you will need to turn on GPRS or WI-FI.

1

2

3

4

5

6



CHAPTER  
7

8

9

10

11

12

13

## RECEIVE AND SEND MESSAGE

1

### **MSN Messenger:**

1. Select " Start " > [Programs] > [Pocket MSN] > [MSN Messenger]
2. Tap { Tap here to sign in }.
3. Enter your MSN or Hotmail email address and password.
4. Select { Sign In }.

2

3

4

### **MSN Hotmail:**

1. Select " Start " > [Programs] > [Pocket MSN] > [MSN Hotmail]
2. Input your MSN or Hotmail email address and password.
3. Select { Sign In } to enter MSN Hotmail Inbox screen.
4. In MSN Hotmail Inbox, you may receive your MSN or Hotmail email through network.

5

6

### **Compose Hotmail:**

1. Select " Start " > [Programs] > [Pocket MSN] > [Compose Hotmail]
2. Input your MSN or Hotmail email address and password.
3. Select { Sign In } to enter MSN Hotmail Inbox screen.

### **MSN Mobile Home Page:**

1. Select " Start " > [Programs] > [Pocket MSN] > [MSN Mobile Home Page] .
2. It will go to MSN Mobile home page.

### **Pocket MSN Help:**

1. Select " Start " > [Programs] > [Pocket MSN] > [Pocket MSN Description] .
2. Select a topic of interest by tapping on the topic.

8

9

10

11

12

13



## CHAPTER 7





## Chapter 8

### USING BLUETOOTH

When you want to form connection through Bluetooth, please make sure the device you would like to make connections with is also equipped with Bluetooth.

## 8.1 Bluetooth Connection Settings

When Bluetooth is activated,  tap icon on Today screen, and you will see  icon in the pop-up window.

Bluetooth is a short distance wireless communication technology. Before using Bluetooth function, please finish connection setup first.

1. Select " Start " > [Settings] > Connections tab > [Bluetooth] > Mode tab.
2. Check { Turn on Bluetooth } after entering Mode tab screen.
3. If you want this device to be detected by other Bluetooth devices, please check { Make this device discoverable to other devices }. (Without checking this function, other Bluetooth devices are unable to detect this device.)
4. Select **Devices** tab to show all connections formed.
5. On **Devices** tab screen, tap **New Partnership** to scan for other devices with Bluetooth function within effective area.
6. On **Devices** tab screen, select the device to be connected, and then select { Next }.
7. It will enter password input screen. After inputting password, select { Next }.
8. It will form connection by entering correct password.

**Note:** You may purchase optional accessory, the device Bluetooth headset.

## 8.2 COM Ports

For example, when you purchase Bluetooth GPS supported navigation software; you can register this device as an effective serial port by following the instructions on the manual of that product and the steps below:

Select " Start " > [Settings] > Connections tab > [Bluetooth] > COM ports tab.

### Register New Serial Port:

1. Select { New Incoming Port } to enter setup screen.

1

2

3

4

5

6

7



CHAPTER 08

9

10

11

12

13

## USING BLUETOOTH

1

2

3

4

5

6

7

2.Select a port to be set.

3.Select { Finish }.



CHAPTER 08

9

10

11

12

13





## Chapter 9

### MULTIMEDIA

# 9.1 Camera

You may use camera function in this device to capture important moments.

1. Select " Start " > [Programs] > [Multimedia] > [Camera] or press and hold **Camera Key** to launch camera.
2. Focus on the object you want to shoot and press halfway and hold **Camera Key** to execute auto focus and then press deeply to take a picture.
3. Use volume adjustment side key to zoom in and out.
4. Tap on the  icon to change camera settings.
5. Tap on the  icon on screen to enter Pictures & Videos.

#### Camera Menu:

 **Video Mode:** Tap on this icon to switch to video mode.

 **Pictures & Videos:** view your photos here.

 **Camera Settings:** to open the menu for camera settings.

#### Settings:

1. **Scene Mode:** you may select different scene modes to fit the shooting environment.
2. **Mode:** you may select different shooting modes for your needs.
3. **Effect:** you may apply many different photo effects.
4. **Size :** 1600 x 1200 (default), 1280 x 960, 800 x 600, 640 x 480, 320 x 240, 160 x 120.
5. **Quality :** Normal (default), fine, low.
6. **Timer Countdown :** Off (default), 5 seconds, 10 seconds.
7. **Sequential Shoot :** 18,12,6,3,Off (default)
8. **Flash :** Auto (default), On, Off.
9. **Storage :** Phone (default), SD . (The storage location will automatically change to Mini SD card if the Mini SD card is plugged in before launching camera).
10. **Shutter sound :** On (default), Off
11. **EV:** Exposure value ranging from -2.0 to +2.0.

# 9.2 Video Mode

1

2

3

4

5

6

7

8



CHAPTER

9

10

11

12



13

## MULTIMEDIA

1

The device camera can also be used as a video recorder to record memorable moments of your life.

2

1. Select " Start " > [Programs] > [Multimedia] > [Camera] >  icon, or directly press and hold **Camera Key** >  icon to enter video mode.

3

2. Focus on the picture you want to film and press **Camera Key** to start video filming.

4

3. Press **Camera Key** again to stop filming.

5

4. Tap on the  icon to change camera settings.

6

5. Select the  icon on screen to enter Pictures & Videos.

7

### Video Menu:

 **Camera Mode:** Tap on this icon to switch to camera mode.

8

 **Pictures & Videos:** view your photos here.

 **Video Settings:** to open the menu for video recorder settings.

### Settings:

**1. Shooting Mode:** you may select different shooting modes to fit the shooting environment.

**2. Effect:** you may apply many different photo effects.

**3. Video Format:** you can select the format you would like to record in.

**4. MMS Video:** you can select to make a recording especially for MMS.

**5. Storage Location:** Phone (default), SD. (The storage location will automatically change to Mini SD card if the Mini SD card is plugged in before launching camera).

## CHAPTER 9

10

11

12

13

## 9.3 Recorder

Use recorder to record voice memo and make note taking simple and efficient.

Select " Start " > [Programs] > [Multimedia] > [Recorder] .

1. Tap on the "Record" icon to activate sound recording function.

2. Tap on the "Record" icon again to stop recording sound.

3. Before you start recording, you may set the recording time in " Duration " to set the duration of the recording.

4. Tap on the "History" icon to show all your recorded files. Tap on any recorded file on your history list to play the file.
5. Tap on the "History" icon again to hide the history window.
6. Tap { Menu } > { Save to } to choose file location.
7. Tap  to leave recorder screen while still keep recording on the background; or tap { Menu } > { Exit }, to stop recording and exit.
8. When recording in the background, tap the icon to return to Recorder. Tap the "Record" icon to stop recording.

**Note:**

If there is incoming call during recording, answering the call will automatically terminate recording. If you want to continue recording after ending call, you need to reactivate recording function.

## 9.4 Photo Editor

You can handwrite messages on photos, or apply colorful frames and stamps by selecting "Start" > Programs > Multimedia > Photo Editor.

## 9.5 Pictures & Videos

You may use [Pictures & Videos] function to manage your photos or videos. In [Pictures & Videos] > [Options], you may resize the picture. In {Menu}, you can also perform functions such as { Set As Today Background }, { Play Slide Show } or { Send }.

By selecting " Start " > [Programs] > [Multimedia] > [Pictures & Videos] , you can

1. enter different folders.
2. select photo arrangement.
3. tap on a thumbnail picture to view the picture, or select { View } to view picture.
4. select { Menu } for more options.

## 9.6 JAVA

1

2

3

4

5

6

7

8



CHAPTER 9

10

11

12

13

## MULTIMEDIA

1

This device supports JAVA, providing you the freedom of using JAVA applications and games.

2

3

4

5

6

7

8

### **9.7 Audio Mixer**

Audio Mixer enables you to configure bass, treble, and 3D effect while listening to the music. Use Media Player to play your audio files and then activate Audio Mixer to adjust the settings. To activate Audio Mixer, tap "Start" > Programs > Multimedia > Audio Mixer.

Note: If you use an A2DP Bluetooth headset to listen to the music, Audio Mixer won't work.



CHAPTER



10

11

12

13





## Chapter 10

### EMBEDDED PROGRAMS

# 10.1 Calendar

### Appointments and Meetings:

You may use [Calendar] to arrange appointments, meetings, and other events. You may view your appointments in different display modes. You may select preferred display mode by tapping on the bottom left of screen to switch between day, week, month, year.

1. Select a date to go to the desired date.
2. Select an appointment on the list to view or edit appointment details.
3. Tap on " Day " (or Week, Month, Year) on the bottom left corner of the screen to switch between display modes.
4. Tap on the keypad icon  to activate or hide screen keypad.
5. Tap on { Menu } on the bottom right corner of the screen to open menu.

Select [Calendar] > { Menu } > { Options }, you may change the display setup of [Calendar] by preference.

### Create an Appointment:

1. Select [Calendar] . Select the date and time of appointment.
2. Highlight the desired date and time, and then select { Menu } > New Appointment.
3. Select " OK " to save the entry and return to calendar.
4. Select " Subject " field to edit the field or select predefined text.
5. Select " Location " field to edit the field.
6. Select " Starts " field to select start time.
7. Select " Ends " field to change End time.
8. You can add your personal notes in **Note** tab.
9. Tap " OK " to save the appointment and return to calendar screen.

If you select **Remind Me** in " Reminder " field, then the device will remind you according to the settings in " Start " > [Settings] > Personal tab > [Sound and Alert] .

### View and Update Calendar:

Select an appointment on the calendar to view appointment summary. If you want to change the details of an appointment, select " Edit " .

1

2

3

4

5

6

7

8

9



CHAPTER  
10

11

12

13

## EMBEDDED PROGRAMS

1

### Send Meeting Notice:

You may use [Calendar] to set meeting notice by combining with the information on Outlook or Pocket Outlook. When you synchronize messages or connect this device with E-mail server, meeting reminders will be generated automatically. Select [Calendar] > { Menu } > Options > Appointments tab, and select desired meeting sending method in "Send meeting requests via" field.

2

3

4

### Generate Meeting Notice:

1. Select [Calendar] > { Menu } > New Appointment
2. Select "Attendees" field. You will enter [Contacts] .
3. Select attendees from the E-mail addresses of your contacts.
4. The new meeting notice will be generated automatically and saved in "Outbox" folder.

5

6

7

8

9

## 10.2 Contacts

### Phone Book:

Contacts helps you manage your phone book.

1. Tap on "Enter a name or number..." field to input part of name or desired or phone number to search for that contact in the contacts list.
2. Tap on "Enter a name or number..." field and enter a letter search for contacts that starts with that letter.
3. Tap on contact's name or phone number to view or edit contact's details.
4. Tap on any contact and hold to open pop-up menu.
5. Select {New} to add new contacts.
6. Tap on the keypad icon  to activate or disable screen keypad.
7. Tap on {Menu} for more options.

### Add Contacts:

1. Select {New} on contacts screen.
2. Select any field to input data in selected fields on screen or panel.
3. Move the scroll bar on the right side of screen to adjust screen display.
4. Select Ringtone field to set a special ringtone for this contact.
5. If you want to add notes, select Note tab to input desired content.

11

12

13



CHAPTER

10

6. Tap "OK" to save and return to contacts.

To save a contact from phone to SIM, tap on that contact in the contacts list and then select "Save to SIM" in { Menu }.

### Searching Contacts:

There are four contact search methods provided in this system.

- Input the contact's name or phone number in input field, and then the contacts list will show the information of this contact. If you want to clear text entered, press **←** key on screen keypad to clear.
- Select { Menu } > { Filter } and select the way to display contacts, by which your contacts list will only display contacts in this category.
- If you want to view the contacts by companies, select { Menu } > { View By } > { Company }, then the contacts list will display in the order of companies. The number of contacts in each company will show on the right hand side of company name.
- To search for a contact, select "Start" > [Programs] > [Search] . Enter the name of the contact in "Search" field and select "Contacts" in "Type" field. Tap on Search to start searching.

### View and Update New Contacts:

Select a contact in the contact list to view contact summary screen. To edit a contact's details, select { Menu } > { Edit } on contact summary screen.

## 10.3 Tasks

You may use [Tasks] to help you track unfinished tasks.

1. To add a new task, tap on "Tap here to add a new task".
2. "!" Represent first priority.
3. Select a single item to enter the details screen of this time.
4. Select a single item and hold to activate the pop-up menu.
5. Tap on { New } to add tasks.
6. You may change the arrangement of the tasks list. On "Tasks" screen, select { Menu } > { Sort By }.
7. You may choose to display a specific task category in your tasks list. Select { Menu } > { Filter }.

1

2

3

4

5

6

7

8

9



CHAPTER

10

11

12

13

## EMBEDDED PROGRAMS

1

### Add a New Task:

1. On "Tasks" screen, select New
2. Select a field to input data.
3. Select "Starts" and "Ends" field to set first and last day of task.
4. You may select Occurs to select whether this task has periodicity.
5. You may select "Reminder" to set a time to remind you or select "None" (unnecessary to alert).
6. To appoint a task as certain category, tap on "Category" field to select a category from the options list.
7. To add notes, select Note tab and input desired content here.
8. Tap "OK" to save the task and return to tasks screen.

2

3

4

5

6

7

8

9

### Check and Update Tasks:

You may select a task from tasks list to view task summary. To change the details of this task, select Edit.

10



## CHAPTER

10

11

12

13

## 10.4 Notes

You may use text notes or voice notes to record information. You may also record voice in [Notes]. If a note file contains voice notes in addition to text, a small icon representing voice notes will appear in the content area of the note. If notes recording is done under the notes file list, then the recording content will be saved as a single file.

Select arrangement of list



Select a file on memo files list to open memo file or play recording content.

Select a file on memo files list and hold to open pop-up menu.

Select New to create a new memo.

Tap on { Menu } > { View Recording Toolbar } to show or hide recording toolbar.

### Add Notes:

1. On memo screen, select New.
2. You may generate memo by writing, drawing, text entry and recording.
  - Tap on the keypad icon  to hide or display screen input panel.
  - Tap on the arrow "▼" next to the keypad icon  to select input method.

- Tap on {Menu} to for options.
- Tap on "OK" to save memo and return to memo screen.

## 10.5 Word Mobile

You may use Word Mobile in this device with Microsoft Word in your computer to easily copy and move document between this device and your computer. Through computer synchronization, you may keep updated contents in both this device and your computer.

You may use your Word Mobile to generate documents like letters, meeting minutes and reports.

If you want to generate a new file, select "Start" > [Programs] > [Word Mobile] > {New}, a new blank document will appear on screen. You may also select default examples from {Menu} > "Options". Your Word Mobile can only open one document at a time. When you open a second document at the same time, this device will ask you to save the first document first. When creating a new document or editing an old document, you may choose to save in the following format: Word file, RTF file and text-only file.

The saved Word Mobile file in this device could be opened by selecting from [Word Mobile] list screen. To delete, copy, or send a file, select and hold desired file names to open pop-up menu.

After opening a Word Mobile file, you may tap {View} to set **Toolbar, Wrap to Window, and Zoom**.

1. Select a folder category shown on list display field.
2. Tap on "Name (or Date, Size, Type)" to change the arrangement of list.
3. Tap on a file to open it.
4. Tap and hold a file to open pop-up menu
5. Tap on {New} to create a new document.
6. Tap on the keypad icon  to show or hide screen input panel and select input method.
7. Tap on {Menu} to open menu for more options.

### Note:

When you are synchronizing or copying files from the device to PC, WordMobile files will be transformed into Word files. While most of the text and paragraphing will be kept during this transformation, some of the format and properties may be lost.

1

2

3

4

5

6

7

8

9



CHAPTER

10

11

12

13

1

2

3

4

5

6

7

8

9



11

12

13

# 10.6 Excel Mobile

You may use Excel Mobile in this device with Microsoft Excel in your computer to easily copy or move files between this device and your computer. Through computer synchronization, you can keep updated content in both this device and your computer.

You may use Excel Mobile to create documents like Statement of Income and Expenditure. If you want to create a new Excel file, tap " Start " > [Programs] > [Excel Mobile] > New, and the screen will open a new Excel file. Your Excel Mobile can only open one file at a time. When you open a second file at the same time, this device will ask you to save first file.

The saved Excel Mobile file in this device could be opened by selecting from [Excel Mobile] list screen. To delete, copy or send a file, tap and hold the desired file name to open pop-up menu.

Your Excel Mobile provides basic worksheet tools, for example, formula, function, sorting and filtering. To show toolbar, tap { View } > Tool Bar.

### Tips:

When working with Excel Mobile, the following tips will help simplify your tasks:

- Select { View } > { Full Screen } to view in full screen. To exit full screen view, tap { View } > { Full Screen } to return to general view.
- You can freeze panes: select a cell, then tap { View } > { Freeze Panes }. You may freeze the top and most left window cell on worksheet. Once you freeze the panes, you can see the frozen window cell no matter where the screen is scrolled.
- You can split the worksheet to view different areas of this worksheet on the same screen. Select { View } > { Split } , and then drag the split line to the desired location. To remove the split, select { View } > { Remove Split }.
- Display or hide full horizontal and vertical lines. To hide a row or a column, select any cell on the row or column you wish to hide, then tap { Menu } > { Format } > { Row } or { Column } > { Hide } . To unhide the a column or row, tap { Menu } > { Format } > { Row } or { Column } , and select { Unhide }.

### Note:

When you are synchronizing or copying files from the device to PC, ExcelMobile files will be transformed into Excel files. While most of the settings will be kept during this transformation, some of the format and properties may be lost.

## 10.7 PowerPoint Mobile







You may use PowerPoint Mobile in this device with Microsoft PowerPoint in your computer to easily copy or move document between this device and your computer. Through computer synchronization, you may keep the files in both this device and your computer updated.

You may use PowerPoint Mobile to browse or play PowerPoint file. If you want to open PowerPoint file, select " Start " > [Programs] > [PowerPoint Mobile] , the screen will show your PowerPoint files list, from which select the file you want to open.

1. Select the folder type demonstrated in the list display field.
2. Select " Name " (or " Date ", " Size ", " Type ") to change the arrangement of list.
3. Select the document to open.
4. Select and hold a document to activate pop-up menu.
5. Select " Open " to open a file.
6. Select the keypad icon  to hide or reveal screen input panel and select input method.
7. Select { Menu } for options.

## 10.8 Windows Media Player

Your Windows Media Player allows you to play sound and video files in this device, select " Start " > Windows Media to activate Windows Media Player.

1. Tap the  icon to view in full screen.
2. Display website, from which find the music and image you want to play.
3. Tap  to return to the beginning of current file or previous file.
4. Tap  or  to play or pause
5. Tap  to skip to next file
6. Tap + or - to adjust volume
7. Tap the  icon to active or disable sound

On Windows Media Player screen, select { Menu } > { Library } to enter library screen.

1

2

3

4

5

6

7

8

9



CHAPTER

10

11

12

13

## EMBEDDED PROGRAMS

1

1. Select library folder

2

2. { Menu } : select < Open File > to open files not in the library. Select { Update Library } to update library list.

3

3. Select and hold the file or folder for playing, and then select { Play } or { Queue Up }.

You may use synchronization to copy sound and image files from your computer to this device. The Windows Media Player in this device can play Windows Media and MP3 files.

4

5

6

7

8

9



### CHAPTER

10

11

12

13

## 10.9 Internet Explorer

You may use the following methods to browse web pages or WAP pages. Select " Start " > Internet Explorer to activate Internet Explorer.

### You may:

Synchronize your favorite URL links on your PC to the device. These URL links are saved in " My Favorite " folders in Internet Explorer on your computer.

Connect to an Internet Server Provider (ISP) or network and browse web pages. First, you must establish internet connection, please see " 6.1 Internet Access ".



If you are connected to an ISP or network, you may download files and programs from the Internet or business Intranet.

### Browsing Internet:

1. Connect this device with the Internet using GPRS or WI-FI.

2. Select " Start " > Internet Explorer

3. Input website address in the blank text field

- Select the icon  next to the blank field to go to the link
- You may use navigation keys or the scroll on browser screen to adjust your screen browsing content.
  - Tap to return to previous page
  - Tap the keypad icon  in the bottom center to hide or reveal screen input panel or select input method.
  - Tap { Menu } to open Menu.
  - Select and hold any location of website content to open pop-up menu.

### View Favorites:

1. On browser screen, select { Menu } > [Favorites] .



## EMBEDDED PROGRAMS

2. On Favorites screen, select the website you want to view.

- Select the website you would like to go to.
- You may add or delete folders or URL links.

### Mobile Favorites Folder:

After installing ActiveSync to your computer, " Mobile Favorites " folder will be added to " My Favorite " in your computer. Only items saved in " Mobile Favorites " can be synchronized with this device. Follow the steps below to add your favorite website to " Mobile Favorites " :

1. On your computer, select Internet Explorer > [Tools] > [Establish Mobile Favorites] .
2. To change name, enter the new name in the new window.
3. To change storage location, select " Create New " to create a new folder or select a folder in the new window.
4. Click on " OK " to add this website to your Mobile Favorites folder.

## 10.10 Magnifier

Enlarge the font and start reading text on your device with ease. Magnifier enlarges the display font like a magnifying glass.

1. Select "Start" > [Programs] > [Tools] > [Magnifier] .
2. Check "Magnifier" and then select OK to save. When you check this option, the font displayed in programs will be enlarged.
3. Check "Menu Magnifier" and then select OK to save. When you check this option, the font displayed in menu will be enlarged.
4. Tap Cancel or " X " on the top right of the screen to exit without saving any changes.

#### Note:

When you check or uncheck "Menu Magnifier" the new settings will take effect after a system reboot.

## 10.11 zip

You can save storage space and increase efficiency of the device by compressing some of

1

2

3

4

5

6

7

8

9



CHAPTER

10

11

12

13

## EMBEDDED PROGRAMS

1

your files with this ZIP tool.

2

### Zipping Files:

- 1.To zip a file, select " Start " > [File Manager] .
- 2.Tap and hold on a file you would like to zip. A pop-up menu will appear.
- 3.Select Zip File in the pop-up menu. In the newly appeared window, you may:
  - Select a file name for the zip file.
  - Select a zip method according to your need.
  - Set a password, which will be asked for when you unzip the file.
4. Select Zip to start compressing the file.

3

4

5

6

7

8

9

### Unzipping Files:

- 1.To unzip a file, select " Start " > [Programs] > [Tools] .
- 2.Select Zip, and then tap the Unzip button on the pop-up window. A list of zipped files will appear.
- 3.You may select a different folder for more zip files. In the file list, tap on the file you would like to unzip.
- 4.Select a location where you would like to extract the file to.
- 5.Tap OK and enter the password (if required) to decompress the zip file.



CHAPTER

10

## 10.12 Calculator

Your Calculator allows you to run simple operations in this device.

Select " Start " > [Programs] > [Tools] > [Calculator] to use your calculator.

11

12

13

## 10.13 Game

You may access [Game] to select games you like in this device for entertainment.

- 1.Select " Start " > [Programs] > [Game]
- 2.Select a game to launch it.

### 10.14 STK (SIM Tool Kit)

The services available depend on your operator. Tap “ Start ” > [Programs] > [Phone Manager] , and then select the STK service provided by your operator.

### 10.15 SD Add-Ons

There may be some add-on applications in the included mini SD card. The install process will be launched automatically when you insert the card into the device. Select the application you want and follow the instructions to install. (Available in selected regions)

### 10.16 SIM Backup

SIM back up makes you can back up the data (Contacts and Messages) from your SIM card to your mobile device or recover from your mobile device to your SIM card.

1. Tap [Programs] > [Phone Manager] > [SIM back up]
2. Select “Backup” to save the data from your SIM card to your mobile device or select “Recover” to restore the data from your mobile device to your SIM card.

### 10.17 GSMART Bluetooth Application

This feature allows you to easily transmit several files to the other Bluetooth device equipping with BT File Exchange program.

1. Tap “Start”> [Programs] > [Tools] > [GSMART Bluetooth Application]
2. Select the Channel you want to use.
3. On the other Bluetooth device, also follow Step 1 and Step 2 (the channel selected on both devices should be the same).
4. On your device, tap {Vcard} or {File}.
5. Select the file you want to transmit.
6. Repeat Step 4 and Step 5 to add more files if you want.
7. If you want to remove certain file, please highlight the file and then tap {Remove}.
8. After file selection is complete, tap {Search Device}.
9. Tap {Transmit} to deliver those files to the other device.

1

2

3

4

5

6

7

8

9



11

12

13

## EMBEDDED PROGRAMS

1

2

3

4

5

6

7

8

9



CHAPTER  
10

11

12

13

### 10.18 GPS Tracking

This feature allows you to record your routes through GPS tracking. You can use any mapping software which supports .kml or .gpx file format, such as Google Earth, to display the routes.

1. Tap "Start" > [Programs] > [GPS Application] > [GPS Tracking] .

After entering GPS Tracking, this device will activate GPS and search for the coordinates. The page shows current connecting information, such as GPS status, Satellites, GPS Time, etc.

2. When GPS connected, tap {Start} to start recording tracks.

3. During tracks recording, tap {Pause} to pause the route tracking, and tap {Start} to resume.

4. When GPS stays connected, tap {Landmark} to create your own landmark ( you can take a picture as your landmark ). The next page allows you to add the name of the landmark and descriptions. Then press {OK} to save the landmark.

5. Tap {Stop} to stop recording routes. On the pop-up window, you may choose to save or cancel the records. If you want to save the record, edit the Beginning, Destination, and File Name; selecting File Type and Save to.

6. Tap {Clean} to clean up all the records unsaved.

\*  on task bar on Today screen shows that GPS is trying to connect.

\*  on task bar on Today screen shows that GPS is connected.

### 10.19 Location Message

This feature allows you to send immediate location through SMS with assigned frequency.

1. Tap "Start" > [Programs] > [Location Message] .

2. In the From and To columns, directly type with text or tap  to insert the saved locations.

\* In the location list screen, you can type a name in the space and select {Add} to add a new location in the list. When highlighting a location, tap {Delete} to delete the data or tap {Select} to insert the location to the columns.

3. In the Contacts column, directly type the numbers or tap  to add a contact from phonebook.

## EMBEDDED PROGRAMS

4. In the Notes column, you can add extra words you would like to show in the SMS.  
5. Tap {Start} to execute the location message. If checked Auto send and selected report frequency with ▲▼, the device sends the location messages automatically basing on assigned time interval. With not checking Auto send, you can tap  on task bar of Today screen to send the location message.

\* "Notes" is showed in the first location message.  
6. To discontinue automatically sending messages, tap {Stop} with a pop-up window querying arrival report.

\*When the device has bad signal reception of GPS or GSM, the short message will be discontinued and a warning window will pop up. If the weak reception lasts for 20 minutes, a pop-up window querying whether to turn off Auto send will show up.

### 10.20 Pocket Remote

Pocket Remote makes you be able to operate and control you mobile device through your PC.

1. Copy the file(【File Explorer】>Pocket Remote > pRemoteC ) to your PC.
2. Use ActiveSync to Connect your PC through USB.
3. Open pRemteC from your PC and click { connect } and then you can control your mobile device from the screen of your PC.

### 10.21 SMS Scheduler

You can write the message and set up whom and date you want to deliver to in advance. Your mobile device will deliver the message as the date comes.

1. "Start" → 【Programs】 → 【Phone Manager】 → 【SMS Scheduler】
  2. Input the date that you want to deliver in front of the message.(ex:2006/08/26 is 060826)
- You have several ways to maintain your device.

You may also update the firmware of your device for improvement if provided. To get the latest firmware, please visit our official website at <http://www.gigabytecm.com/>

1

2

3

4

5

6

7

8

9



CHAPTER

10

11

12

13



## Chapter 11 DEVICE MAINTENANCE

1

2

3

4

5

6

7

8

9

10



CHAPTER  
11

12

13

# 11.1 Memory Management

Select " Start " > [Settings] > System tab > [Memory]

### Main tab:

Display current memory status of this device.

### Storage Card tab:

Display the memory status of storage card in this device.

### Running Program tab:

Display all current running programs in this device.

Select any program from " Running Programs List ", you may select to " Activate " or " Stop".

**Activate:** run the highlighted programs

**Stop:** stop running highlighted programs

**Stop All:** stop running all programs on " Running Programs List "

# 11.2 Memory

When the memory is insufficient, this device cannot automatically allocate memory, you may follow the steps below to free up more memory:

1.Select " Start " > [File Explorer]

2.Use [File Explorer] to move some files to mini SD card. Select and hold highlighted items by stylus and select " Cut " or " Copy " on the pop-up menu; then select " Paste " after switching to mini SD card.

3.Use [File Explorer] to delete the unwanted files.

Select " Start " > [Messaging] > { Menu } > Tool > Options > Storage tab. If you have inserted a memory card, check " Save Attachment to Memory Card " and E-mail attachments will automatically be saved to memory card.

Select " Start " > [Internet Explorer] > { Menu } > Tool > Options > Memory tab.Select { Clear History } and { Delete File } to delete browsed web page related record.

## 11.3 Add or Remove Programs

All programs installed in the device will be saved in ROM (Read Only Memory) and are not removable. Data saved in ROM will not be lost by accident. As long as there is sufficient space in this device, you may install suitable programs by preference.

### Add Programs through ActiveSync:

1. Before installing the program, please make sure that the device processor is suitable for the software.

Select " Start " > [Settings] > System tab > [About] > Version tab to check for information of this device.

2. Download the desired software to your computer. (Please select software that are designed for Pocket PC and this device)

3. Read installation instructions, 'Readme' file, or accompanied programs provided to you.

4. Connect your computer with this device.

5. Install executive file to your computer.

- If this file contains installation program, the installation wizard will automatically activate. Please follow the instructions on screen. Once the installation on your computer is complete, the program will automatically be installed to this device.

- If this file does not contain any installation program, an error message will show on the screen and tell you this program is invalid, which is not suitable for your computer. You must move this program to this device manually. If you cannot find any installation instructions for this program, please use 'Browse' function of ActiveSync to copy program file to Program Files folder in this device.

After completing installation, select " Start " > [Programs] , and then select the program icon to launch that program.

### Add Programs through Internet:

You may download software suitable for this device from Internet.

1. Before installing the program, please make sure that the device processor is suitable for the software.

Select " Start " > [Settings] > System tab > [About] > Version tab to check information in this device.

2. Directly download programs to this device by using Internet Explorer in this device.

1

2

3

4

5

6

7

8

9

10



CHAPTER

11

12

13

## DEVICE MAINTENANCE

1

(Please select programs designed for Pocket PC and this device)

2

3. Read installation instructions, 'Readme' file, or accompanied programs provided to you.

3

4. Run installation executive file in your computer.

4

### **Add Programs to “Start” Menu:**

Select “ Start ” > [Settings] > Personal tab > [Menus] .

5

1. Check the programs to be displayed on “ Start ” menu.

6

2. Point “ OK ” to save settings and return to **Personal** tab screen.

7

### **Remove Program:**

Select “ Start ” > [Setup] > System tab > [Remove Program] .

8

- Select the programs you would like to delete from “ Programs in storage memory ” list, and then select “ Remove ” to delete highlighted programs.

9

If the installed programs list does not contain the program you intend to remove, you may use [File Explorer] in this device to find the program and delete it by selecting and holding the program's name and then select { Delete } from the pop-up menu.

10



CHAPTER

11

12

13





## Chapter 12

### SPECIFICATIONS

Item	Specifications
System Information	
Operating System	Windows Mobile 5.0 (AKU3)
Processor	Intel PXA 270 520 MHz
Memory	256 MB ROM, 64MB RAM
Size	
Dimensions (mm)	102.5 x 51.5 x 19 mm
Weight (in grams)	116 g
Batteries	
Battery Capacity	920mAh Li-Ion Battery
Standby time	110 hours
Talk time	4 hours
Charging time	
Charger	2.5 hours
Display Characteristics	
Type	2.4 inch, 260K TFT LCD touch screen
Resolution	240×320 pixels
Band	
Band	GSM 900/1800/1900
Connectivity	
Bluetooth	Bluetooth 2.0
WLAN	WLAN 802.11b+g
GPRS	GPRS Class A/B, GPRS Uplink/Downlink Class 10
WAP	WAP 2.0
CSD	Y
Modem dial-up	Y
USB	Mini USB 2.0
Image	
Format	JPEG, GIF, PNG, BMP, WBMP
Max Size(per)	Depends on available RAM
Audio	
Format	WMA, MP3, MID, AMR, WAV, AAC
Max Size	Depends on available RAM

1

2

3

4

5

6

7

8

9

10

11



CHAPTER

12

13

## SPECIFICATIONS

1

2

3

4

5

6

7

8

9

10

11

12

13

Video	
Format	3GP, MPEG4, WMV
Max Size	Depends on available RAM
Phonebook	
Size	Depends on available RAM
Ringtone	
Type	MP3, WMA, AMR
Polyphone	192 polyphonic mid file
DSC	
Type	JPEG
Pixels	2.0 mega pixels, 1600×1200 (UXGA)
Resolution	UXGA, SXGA, SVGA, VGA, QVGA, QQVGA
Auto Fucus	Y
Macro Mode	Y
Video Recording	Y
Message	
Push E-Mail	Windows Direct Push
SMS	Y
MMS	Y
- Audio Format	AMR, MP3, MID
- Video Format	3GP, MP4
- Image Format	JPEG, GIF, PNG, BMP, WBMP
E-Mail	Y
MSN	Y
External Memory	
Type	Mini SD card
Max Size	No limit
Operating Temperature	
Temperature	-10°C~45°C



CHAPTER

12



## Chapter 13

### FAQ

#### Q1

#### Why can't I turn on the device?

**Ans :**

Please make sure that the device has sufficient power, and that the battery is secured in the device.

Plug the device to an outlet using the travel charger. Check whether the LED light on the device has lighted up, and then press the power key on the device to turn on the device.

#### Q2

#### Why does the screen freezes and does not respond to my commands or input?

**Ans :**

Reboot the system to free up memory. The system shall operate more efficiently. If the system still lags after rebooting, you will need to clean boot the device. To clean boot, press Flag key, OK key and the power key at the same time for about 3 seconds and then release. Your device will reset to factory defaults and reboot.

**Note:** When you perform a clean boot on this device, all your personalized settings, information, and programs installed will be removed. The system will reset to factory defaults.

#### Q3

#### Why can't my device make any sound alerts?

**Ans :**

Tap on the speaker icon  on the top right corner of the screen, and then adjust the alert or ring volume.

You could also use the volume key on the left side of the device to adjust volume. (See 3.4 Volume Adjustments for details.)

#### Q4

#### Why would the screen darkens automatically?

**Ans :**

This is a power saving mechanism. You can change this setting in "Start" > Settings > System tab > Backlight > Battery Power tab & External Power tab.

1

2

3

4

5

6

7

8

9

10

11

12

QA

CHAPTER  
13

13

## FAQ

1

2

3

4

5

6

7

8

9

10

11

12

QA

CHAPTER  
13

### Q5

#### When I open a file or a program, a “Insufficient Memory” message pops up.

**Ans :**

The device memory is shared by both storage and programs. You can follow the steps below to free up some memory.

Remove some of the rarely used programs you installed.

Remove rarely used files.

(See 11.2 Memory for more details.)

### Q6

#### Why doesn't the screen respond accurately to my stylus taps?

**Ans :**

Select “Start”>Settings>System tab>Screen>General tab. Select “Align Screen” to align the screen.

### Q7

#### Why does the device launch wrong programs or ignore my command when I press a device key?

**Ans :**

Select “Start”>Settings>Personal tab>Buttons and check whether the programs assigned to each key is correct. You can change these key assignments by preference.

### Q8

#### My device can't form a successful connection with ActiveSync.

**Ans :**

Please make sure you have installed ActiveSync 4.2 on your computer. You can find ActiveSync in the installation CD, or you can download the latest version from Microsoft's website.

Please make sure you have connected the device to the computer by plugging in the USB cable to both the device and the computer.

Make sure that you are not running another program that is using the same serial port.

If the connection still fails, remove ActiveSync on your computer and reinstall.

**Q9****How do I take out the mini SD card from the SD adapter?**

**Ans :**

The card slot on this device is designed for mini SD cards. To remove the mini SD card from the SD card adapter, please hold the SD card adapter with one hand, slightly lift the end of the mini SD card and pull.

**Example:**

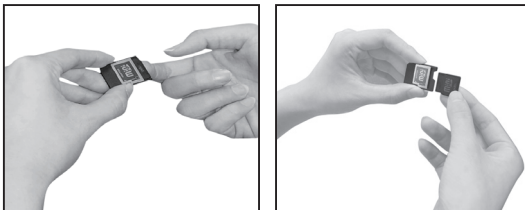
**Q10****Why are there double entries in my Contacts list?**

**Ans :**

You may have selected “Show SIM Contacts” in Contacts menu. If you have already copied your SIM contacts to the device, then you do not need to select “Show SIM Contacts”.

**Q11****Can I synchronize information with PC and Exchanger Server at the same time?**

**Ans:**

No, you only can either synchronize information with PC or with Exchange Server at one time.

1

2

3

4

5

6

7

8

9

10

11

12

QA

CHAPTER

13

FAQ

1

2

3

4

5

6

7

8

9

10

11

12

Gsmart i300

GIGA-BYTE COMMUNICATIONS INC.

8F, No. 43, Fu-Hsin Road, Hsin-Tien, Taipei Hsien, Taiwan

+886-2-22186161 [www.gigabyte.com](http://www.gigabyte.com)

QA

CHAPTER

3

FAQ

1

2

3

4

5

6

7

8

9

10

11

12

QA

CHAPTER

13